

ABSORB 130

IMPACT ATTENUATOR WITH TRIPLE CONTAINER MODULES

Code: ABSORB-130



PATENT PENDING
PenMX/u/2019/000516

FEATURES

- No metal parts.
- Modules with triple-container system:
- Plastic outer container (roto-molding).
- 2 inner flexible containers with high resistance to tear and punching shear.
- Airtight seal cap with pressure relief valve.
- No water loss through evaporation.
- It doesn't require maintenance to fill with water.
- Option to include lateral reinforcement of solid plastic manufactured in intrusion molding solid plastic.
- It is complemented with preventive elements: such as:
 - Luminus road stud
 - Delineator post 105
 - Super flexible Delineator post 76 (poliflexy)

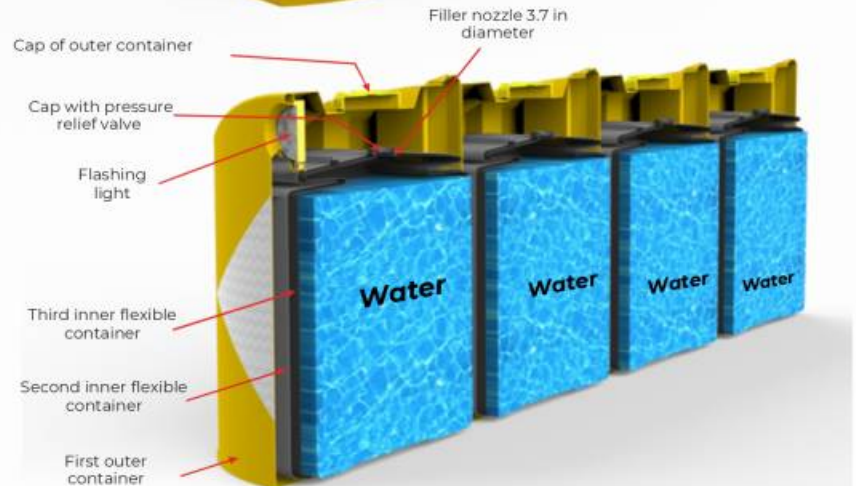

ABSORB 130

IMPACT ATTENUATOR WITH TRIPLE CONTAINER MODULES

Code: ABSORB-130

COUPLING SYSTEM



FEATURES

- Absorb 130 is integrated by a front module, along with universal modules, depending the number of modules this can get to a test level TL-3 in accordance with the NOM-008-SCT2-2013 standard and close with an end cap to provide support when filled with water.
- Modules are assembly through a coupling system designed specially to all the modules work together without separating at the moment of the impact.
- The new **"IMPACT ATTENUATOR BY TRIPLE CONTAINER MODULE SYSTEM"** consists that each module is integrated by an outer container which on the inside has a second flexible container, and this second has on its inside a third flexible container which is fill with water up to 80% of capacity of the outer container.
- ABSORB 130 is ideal for highways, high speeds roads, and is designed to avoid vehicles collision against elements as bridge structures, toll booths, posts, trees, et al; absorbing or cushioning the strength of the impact and reducing speed of vehicles in the most safe and controlled manner, helping to reduce gravity of the suffered injuries in this type of accidents.
- The outer containers of the modules are manufactured in medium density polyethylene with UV-protection that offer a great resistance to environment exposure.
- Front module has a solar flashing light that makes this device visible at great distance.
- The inner flexible containers have a security valve and airtight seal filling that avoid loss of water through evaporation and facilitates its filling.

ABSORB 130

IMPACT ATTENUATOR WITH TRIPLE CONTAINER MODULES

Code: ABSORB-130

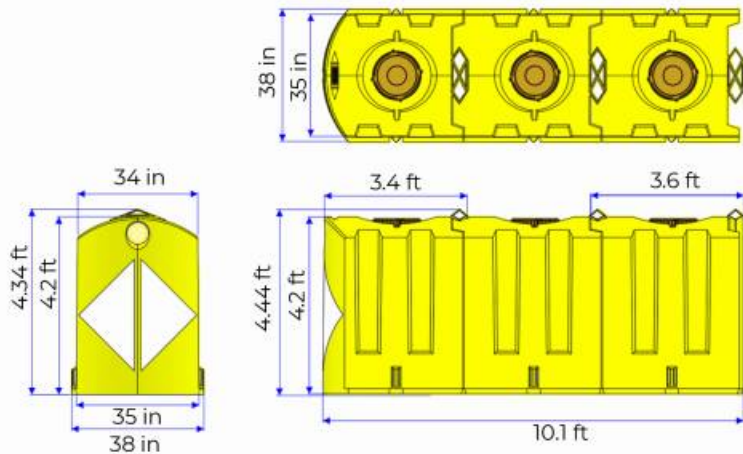

Test Level: TL-1
Speed: 31.06 mph.
Empty weight: 330 lb.
Weight with water up to 80%: 6062 lb.
1 front module, 2 universal modules.

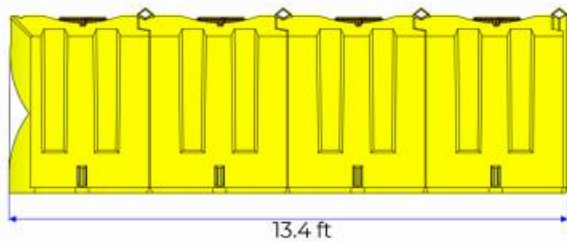

Test Level: TL-2
Speed: 43.4 mph.
Empty weight: 440.9 lb.
Weight with water up to 80%: 7594.9 lb.
1 front module, 3 universal modules

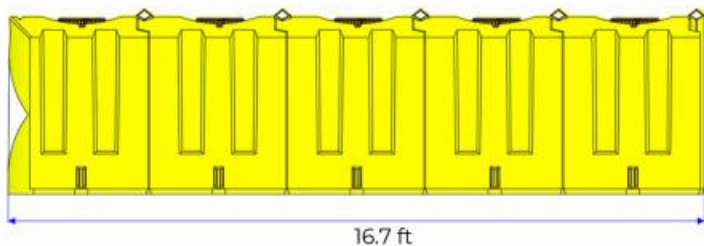

Test Level: TL-3
Speed: 62.1 mph.
Empty weight: 551.1 lb.
Weight with water up to 80%: 9523 lb.
1 front module, 4 universal modules

ABSORB 130

IMPACT ATTENUATOR WITH TRIPLE CONTAINER MODULES

Code: ABSORB-130

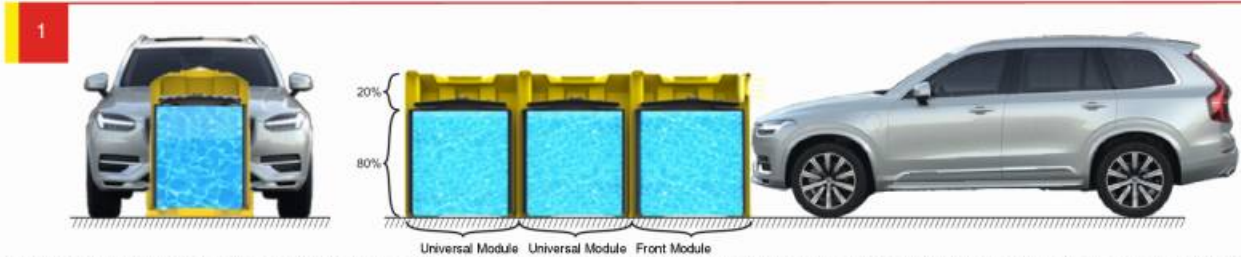

The assembling of the inner flexible containers of each module is filled with water up to 80% of capacity of the outer container, the residual air is removed from the assembling of inner flexible containers, then it is airtight sealed through a cap with pressure relief valve and the assembling is bend to the inner of the outer container.

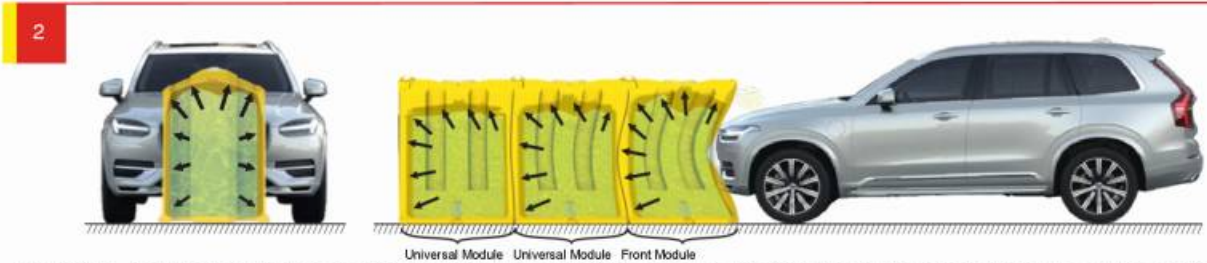

From the moment a vehicle makes contact with the first module, begins the cushioning; then the outer container is deformed and is able to crack, the inner flexible containers are smashed, the water moves and make the inner flexible containers to adapt the shape of the front part of the vehicle.



If the pressure exerted during the impact or collision is too high, the relief pressure valve is opened and allows the water to come out in a controlled manner, so part of the pressure exerted on the water is released and the contact time between the vehicle and the triple container system is longer.

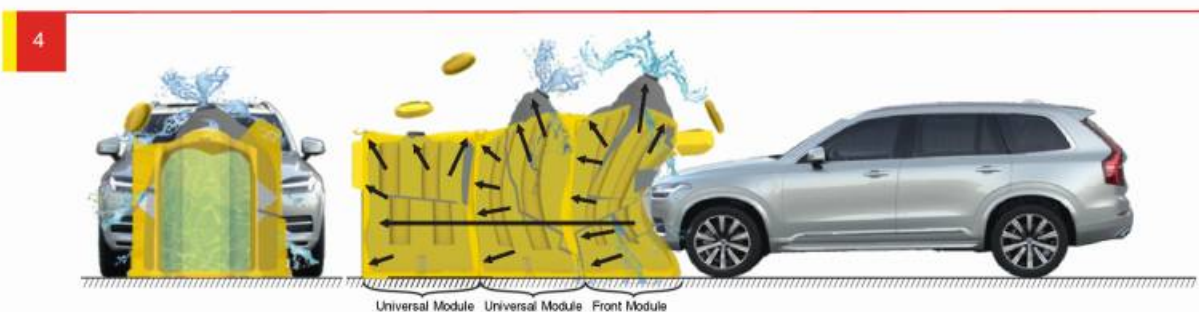

In case, during the impact the assembling of the flexible containers is punctured, the water will come out through those punctures releasing the pressure exerted on the water, but the assembling won't explode, thus increase the ability to cushion the impact.