

DOUBLE SOLAR ARROW BOARD 760 / CLUSTER

Code: FS-760/CLUSTER D

FEATURES

- Road signage devices essential in different transit and work situations.
- Work with solar energy, avoiding the need of other external power supplies and reducing environmental impact and operational costs.
- Equipped with clusters of high intensity LED lighting, ensuring signs are clearly visible during night and day, improving road safety, even in foggy conditions.
- Resist corrosive and saline environments, ideal to use in many environments, including coastal and industrial areas.
- Lightweight and portable device allows to be set and moved by one person; becoming into a convenient option for projects in constant change.
- These luminous arrow boards provide effective and adaptable solutions to different road and work signage needs, guaranteeing maximum safety and efficiency in any environment.

4 MOUNTING OPTIONS

- Mounted on **2"x2" Posteflex® over a turtle type base** that can be filled with sand, guaranteeing stability and safety in environments where wind or movement can cause issues.
- **Mounting on tripod** for a portable and easy mobility of the device, allowing a fast set in different locations, ideal for events or activities in many spaces.
- **1" RHS steel structure** includes swivel casters that ease maneuverability, offering a perfect solution for situations that require constant mobility without sacrificing stability.
- **Steel hooks** secure the equipment of a truck, providing a mobile solution that maintains visibility during transport, ideal for operations with frequent movements.



POSTEFLEX®
TURTLE BASE



TRIPOD



STRUCTURE

HOOK



Handle

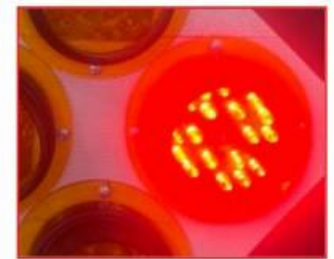

Ultrabright LED



Solar cell

DOUBLE SOLAR ARROW BOARD 760 / CLUSTER

Code: FS-760/CLUSTER D

FEATURES

- Manufactured in a single piece to one side of black polymer.
 - Handle to ease use and maneuverability.
 - High resistance to temperature changes and adverse climate conditions, protection against UV rays ensuring durability and prevention of discoloration.
 - Resistant to humidity, ideal to use in outdoors.
 - IP68 Waterproof electric system.
 - Recyclable, developing the environmental sustainability.
 - It doesn't rust, maintaining its structural integrity over time.
 - Design that allow to stock several units, optimizing transportation and storage costs.
- **Lighting:** 12 acrylic clusters in amber or red color with light diffusers to optimize it.
 - Photovoltaic panel of 670 mm x 235 mm x 25 mm of 30W silicon, 6V, allowing energy autonomy.
 - Rechargeable battery of 13.4mA, guaranteeing approx. 24 hours of continuous functioning with a complete charge.
 - Robust, functional and sustainable design, adapting to multiple signage and warning needs in outdoors.
 - Made of plastic material, without resale value to dissuade thefts.
 - It can work during day and night, 24 hours.



DOUBLE SOLAR ARROW BOARD 760 / CLUSTER

Code: FS-760/CLUSTER D

MEASUREMENTS

Dimensions and other measures are nominal and may vary by + / - 2 %.

General of Board

- Length: 31.4 in
- Width with cluster: 3.5 in
- Height: 25.1 in

Cluster Board

- Length: 29.9 in
- Height: 24.0 in

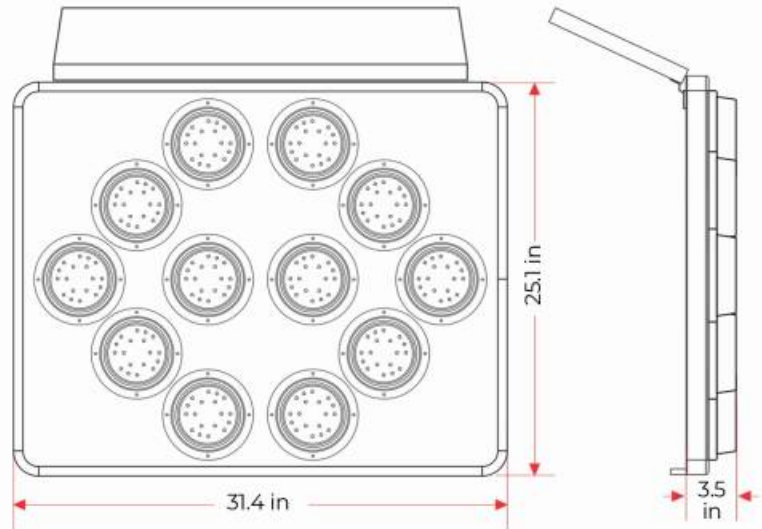

LIGHTING SYSTEM

Luminous Modules	12 LED clusters with LED holders, protective mica and butyl seal.
SOLAR PANEL MONO -30W	
Lighting Color	Amber or red
Maximum Power (Pm)	30W
Short Circuit Current (Isc)	5.0A
Open Circuit Voltage (Voc)	6.0V

HORIZONTAL board with TWO-WAY ARROW
Flashing system through a pushbutton control circuit that allows to display 08 functions.

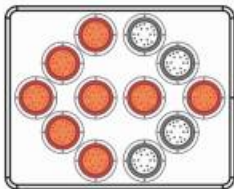

FLASHING
LEFT ARROW

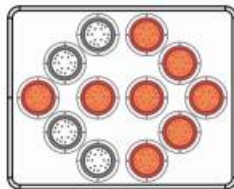

FLASHING
RIGHT ARROW

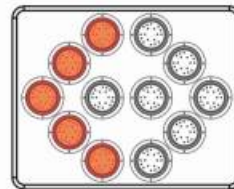

FLASHING LEFT
CHEVRON

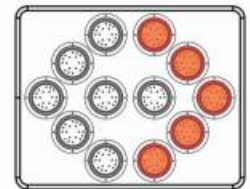

FLASHING RIGHT
CHEVRON

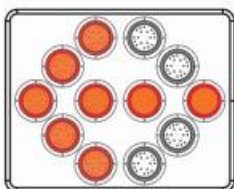

SEQUENCE
LEFT ARROW

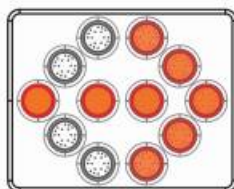

SEQUENCE
RIGHT ARROW

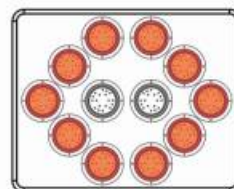

DOUBLE
FLASHING

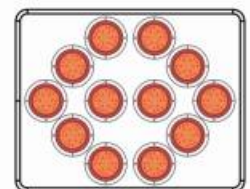

FLASHING
STOP