









STREET SIGN

770



**TRANSFORM YOUR STREET SIGNS:
TAKE THEM TO THE NEXT LEVEL**

TABLE OF CONTENTS

-  **01** WHAT IS IT? 2
-  **02** FEATURES 3
-  **03** MEASURES 4
-  **04** INSTALLATION 6
-  **05** LABEL/SIGN EXAMPLES 7
-  **06** CONTACT US 10



WHAT IS IT?

Perfect to improve signage and inform pedestrians.

In addition, these are designed in one piece and include support to anchor.

Our street signs are 100% water and vandal-proof.

These are highly recommended for hotels, malls, tourist centers or self-service chains.

We guarantee a maximum resistance and durability. Ideal for cities and municipalities with great pedestrian flow or meeting points.

We have three versions: 770 with light, solar 770 and New City 770

770 WITH LIGHT



SOLAR 770



NEW CITY 770



FEATURES

770 WITH LIGHT

- Street sign presents a lightweight body manufactured in RCB polymer in white color, allowing an optimal light transmission.
- Our LED technology of low energy-consumption contribute to environmental respect. The ON/OFF system, managed by a photo-electric electronic sensor, ensures a light efficiency adapted to your specific needs.
- Thanks to their high luminosity, is possible to light 6 meter radius area.



SOLAR 770

- Integral Design: Manufactured in RCB polymer in white color, unique structure with 2 joins, for a firm fastening to pole, providing a flawless aesthetic.
- Advanced Technology: JVM power system and 3V, 1.65W solar panel with "AAA" batteries of 1100mA, guaranteeing an optimal performance
- Sustainability: 100% recyclable, contributing to environmental preservation.



NEW CITY 770

- Manufactured in RCB polymer in black color, molded in one piece, with two straps for a safe and uncomplicated installation.
- Street Sign transforms into a vandal-proof element, ideal to indicate locations and to be used as an advertising platform.
- Sustainability; 100% recyclable, contributing to environmental preservation.





MEASURES

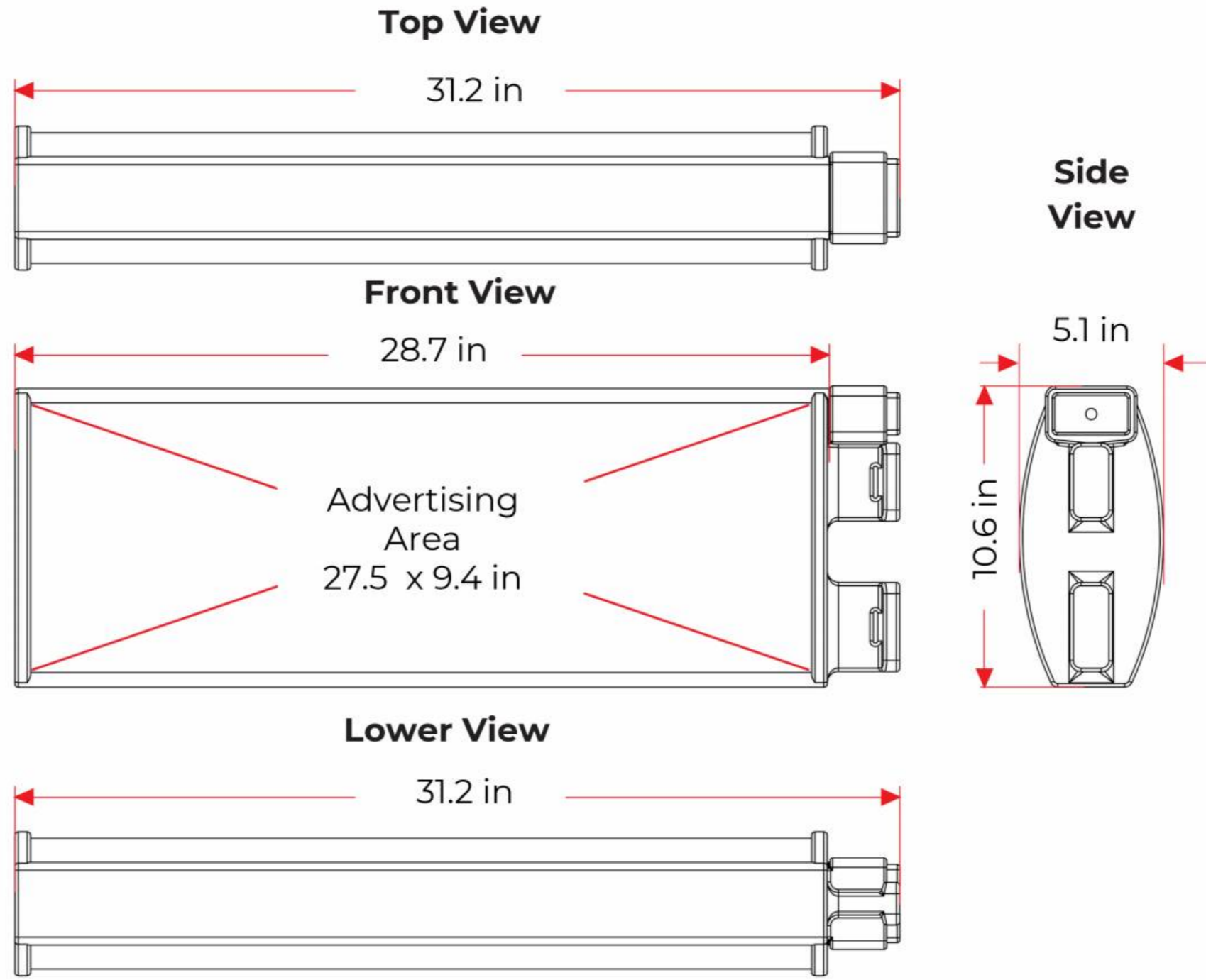

770 WITH LIGHT

Top View



Front View



Lower View



Side View



NEW CITY 770

Top View

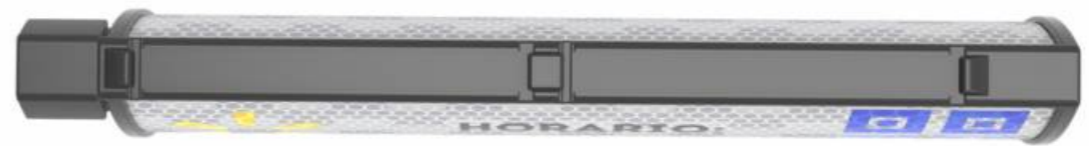

Front View



Lower View



Side View



MEASURES

Top View

31.2 in

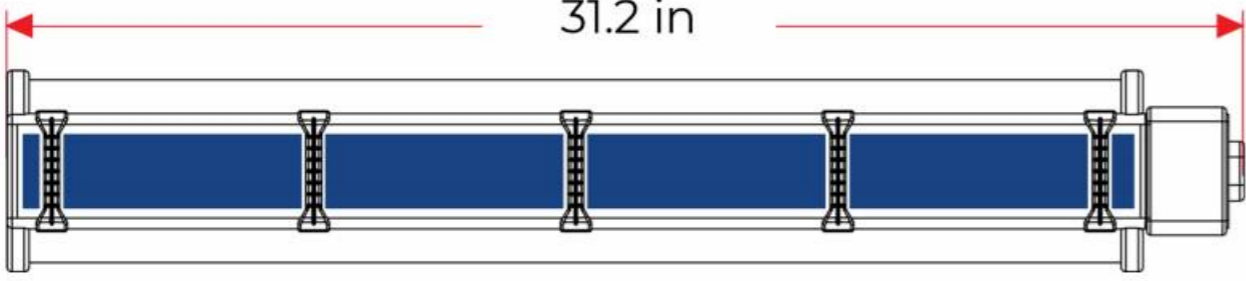

Side View

5.1 in

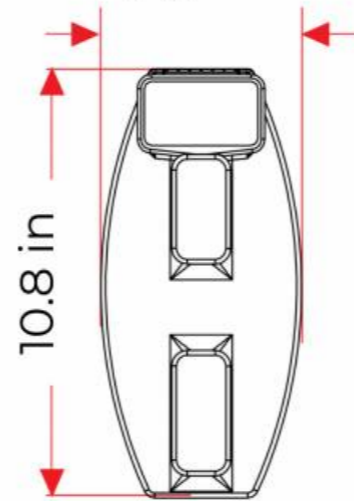

Front View

28.7 in

Advertising Area
27.5 x 9.4 in

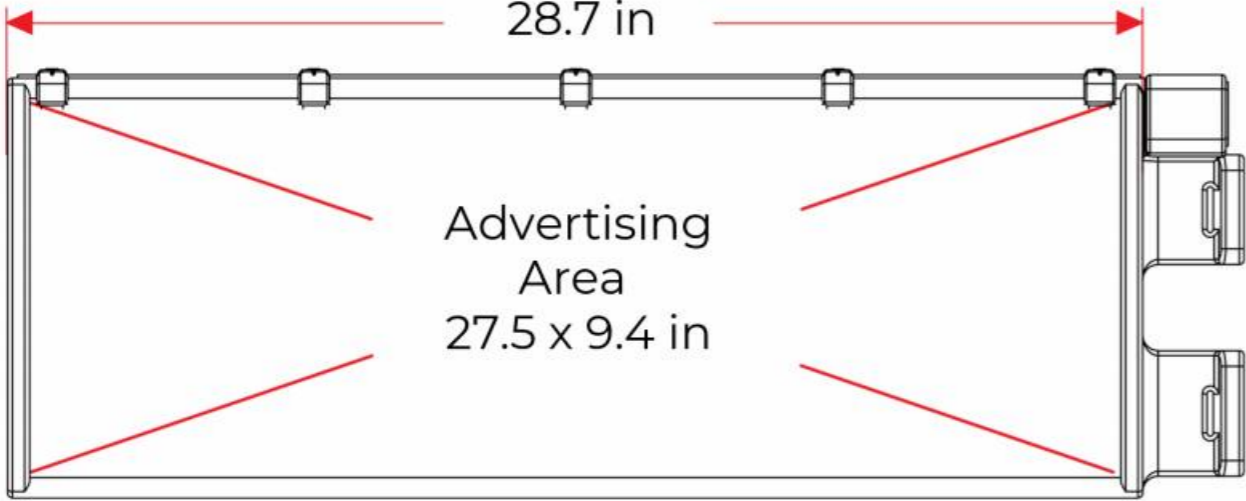

Lower View

31.2 in



SOLAR 770

Top View



Side View



Front View

Advertising Area



Lower View

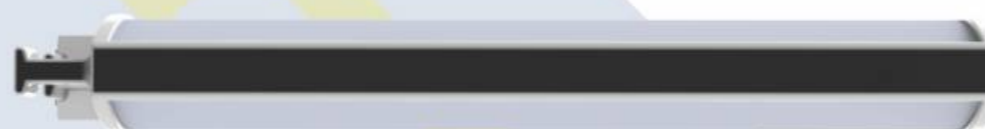



INSTALLATION



- Safety system with straps included:

The safety system is equipped with straps, providing a complete and reliable solution for your tranquility.



Pyramid shaped



2 integrated joins



- With 2 integrated joins for their installation. A vandal-proof street sign, easy to install and can be used as advertisement.



Installation with straps





LABEL/SIGN EXAMPLES

NEW CITY 770

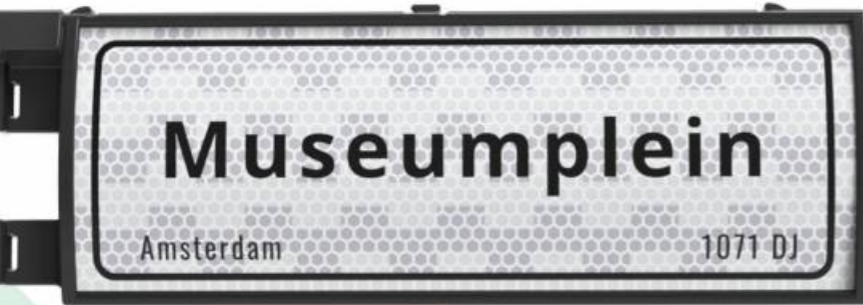

LABEL/SIGN EXAMPLES

NEW CITY 770

STREET SIGN 770 WITH LIGHT

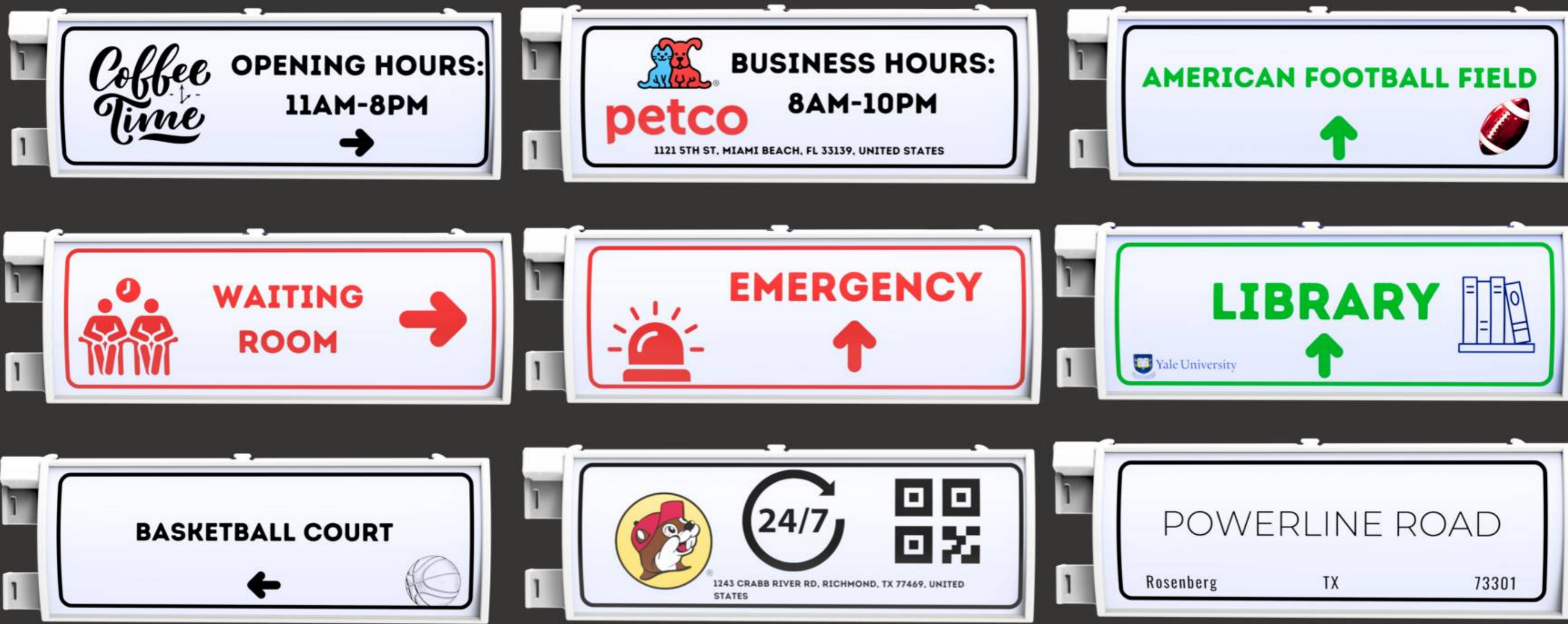

SOLAR STREET SIGN 770

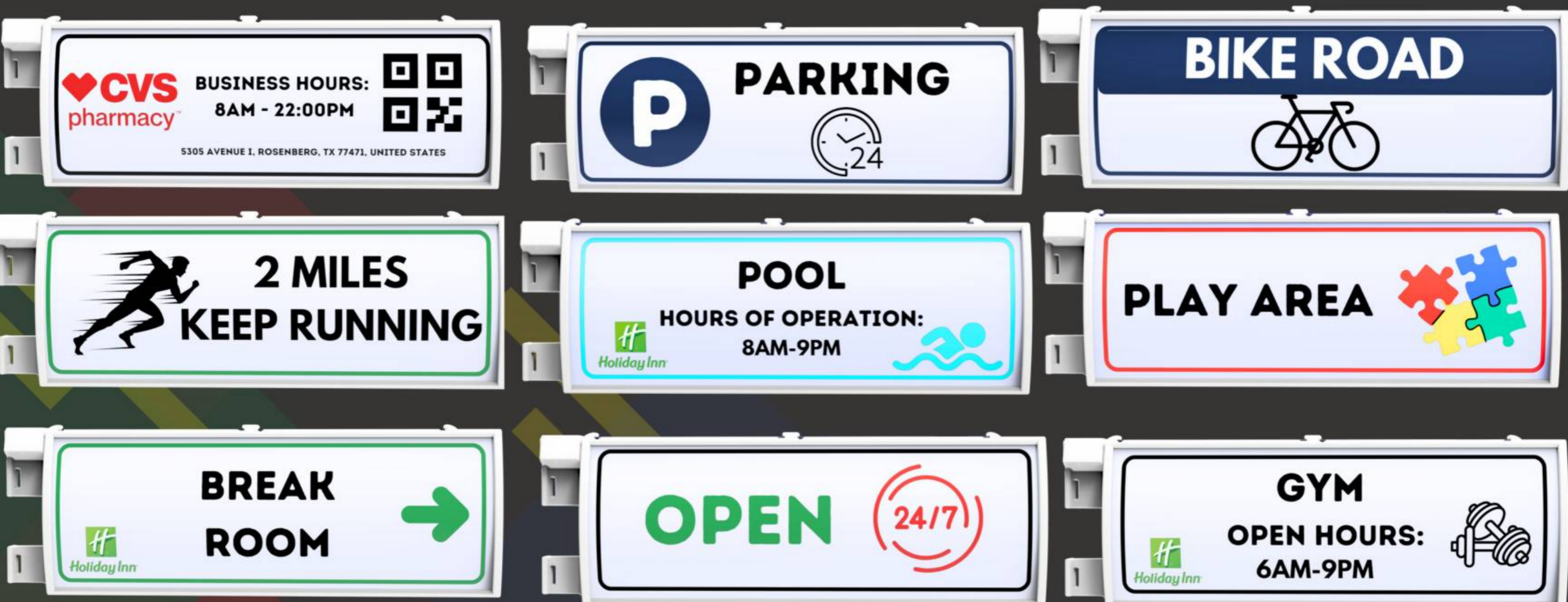

LABEL/SIGN EXAMPLES

NEW CITY 770

STREET SIGN 770 WITH LIGHT



SOLAR STREET SIGN 770

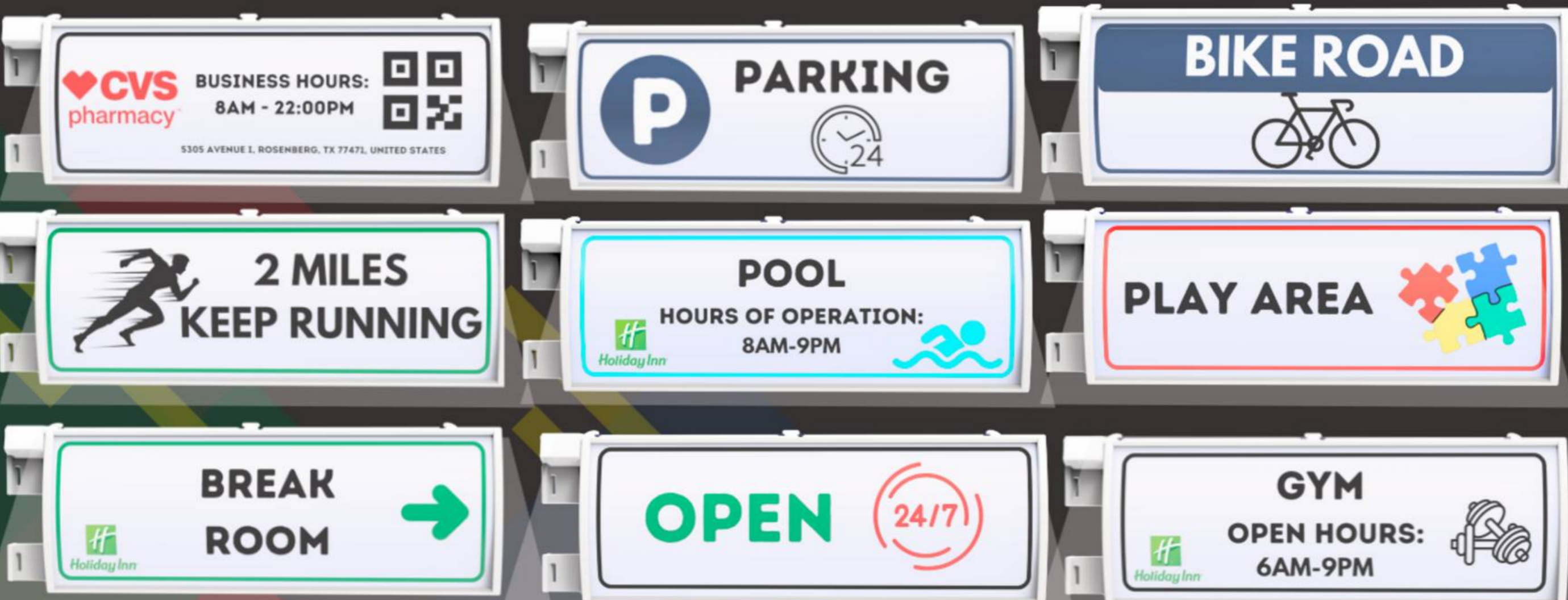



CONTACT US

 **88-A lago Ayarza, Miguel Hidalgo, CDMX**

 **Phone Number +52 (55) 5399-8671**

 **Whatsapp +52 (55) 8811-2082**

 **<https://multisenal.com>**